

SERIE SV-I120

SV-I120

Es un sistema para hojas correderas de hasta 120 kg por hoja, en acero inoxidable. El perfil superior de forma circular tiene la robustez para soportar el peso de distintas hojas colocando los soportes en los lugares indicados. Las roldanas son de rodamientos a bolas y de acero inoxidable. El modelo dispone de soportes para pared, vidrio y techo según el tipo de instalación a realizar, también de acero inoxidable y banda de rodadura de nylon negro. También dispone de guiador inferior. Uno de los requisitos de SV-I120 es que las hojas de vidrio sean templadas ya que son mecanizadas. La espectacularidad de este modelo viene dado por su diseño y por todos sus mecanismos visibles. Vidrio 10/12 mm.



Características técnicas:

- Especificaciones:



SECCIÓN TIPO

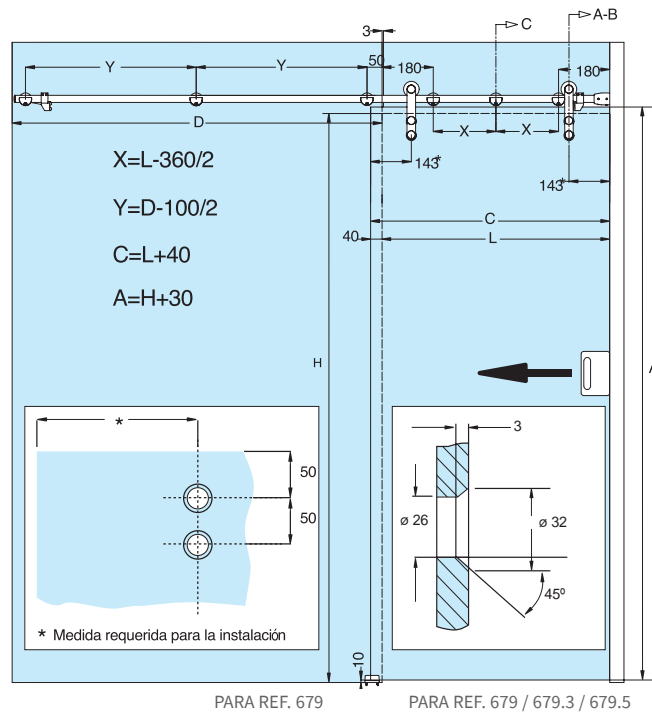
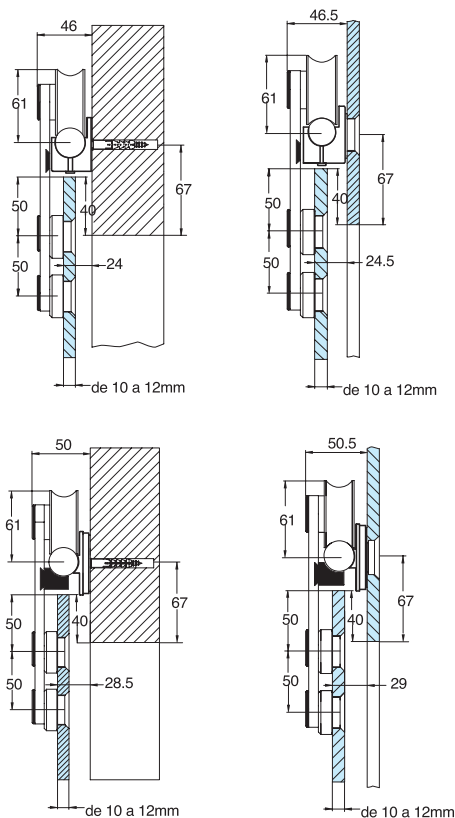

VARIANTES DE INSTALACIÓN:



SERIE SV-1120

COMPONENTES

**PERFIL AÉREO
PARA 120 KG Ø 25 MM**

Acabados:

Inox mate	2000 mm	2945.2 IM
	3000 mm	2945.3 IM
	6000 mm	2945.6 IM

120/20
120/30
120/60
120/22
120/32



**PERFIL MECANIZADO
PARA SOPORTES OCULTOS**

Acabados:

2000 mm (5 agujeros)	2945.20 IM
3000 mm (7 agujeros)	2945.30 IM

**JUEGO COMPLETO
DE ACCESORIOS
PARA 120 KG**

Vidrio 10/12 mm
No incluye soportes a
pared o vidrio

679 IM



120/00

**SOPORTE ROLDANA
ANTIDESCARRILAMIENTO**

679.1

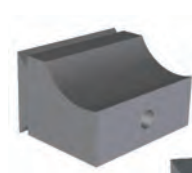

120/68
120/69

SOPORTE ROLDANA

679.2



SOPORTE A VIDRIO

679.3 IM



120/61
120/62

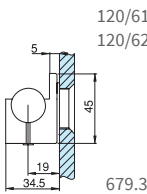

SOPORTE OCULTO A VIDRIO

679.5 IM



120/63
120/64

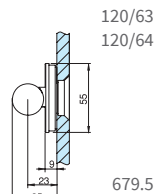

SOPORTE A PARED

679.4 IM

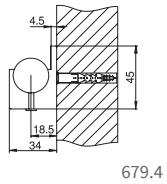

SOPORTE OCULTO A PARED

679.6 IM

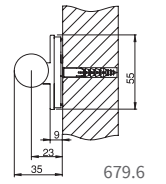

SOPORTE A TECHO

Montaje junto con ref. 679.4 ó 679.6

679.10 IM



120/70

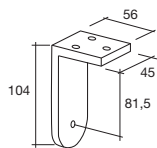

SOPORTE A TECHO DOBLE

679.13 IM



120/71

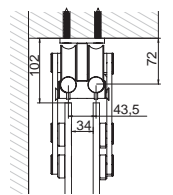

JUEGO TOPES FRENO

679.15 IM



120/56

**SOPORTE PARA HOJA
PERPENDICULAR FIJA**

679.14 IM



120/73